

Tapp "#\$a'd\$\$%&'TST&((
O)*## "#\$a,- "e\$

® \$

! "\$%&ent'(ee)e)'to'+#,'-./0-s'1-\$n'to'233'%s\$

DaB SheetNo. 33500-2

Date 11.2023

Sealed 2.2018

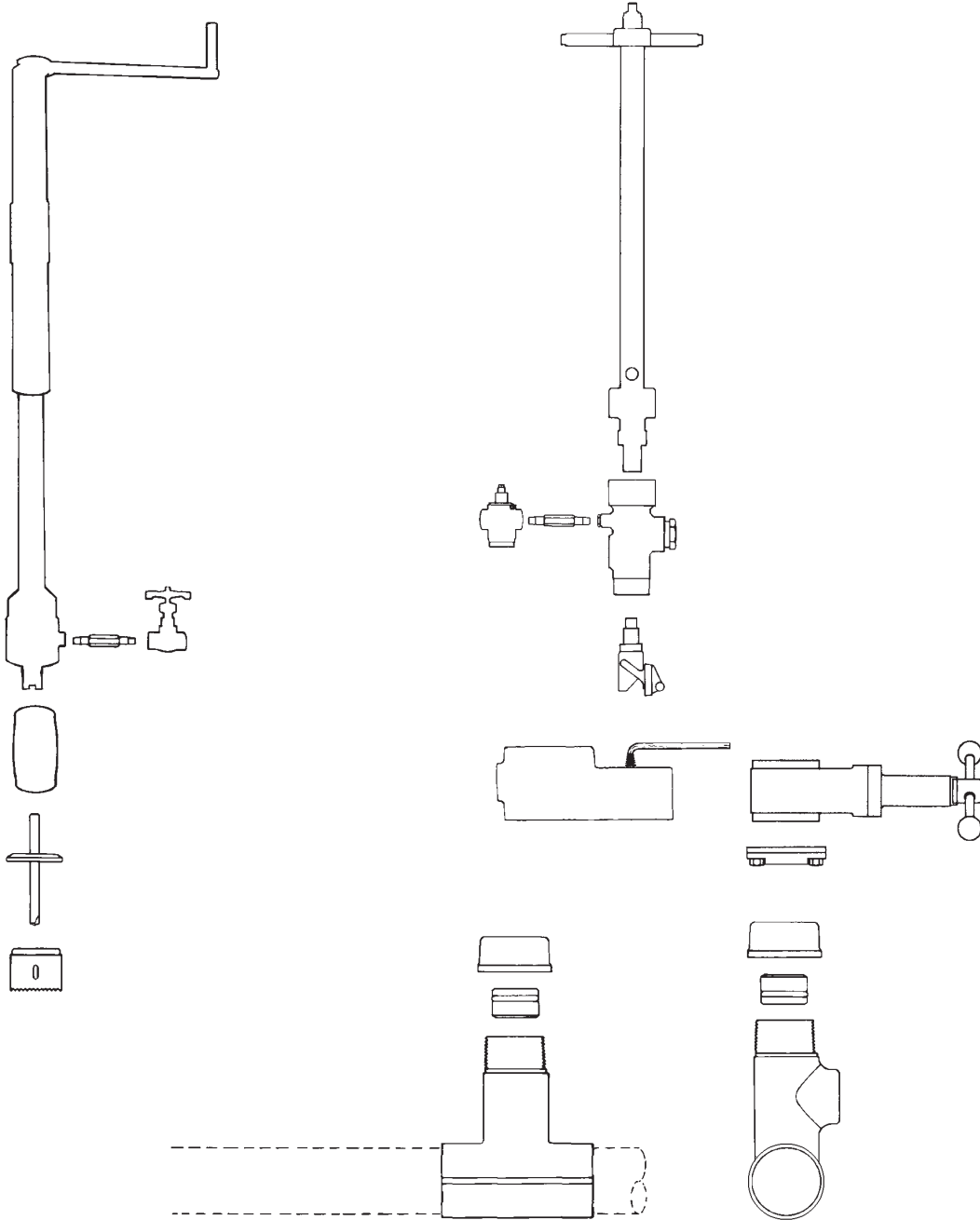

4-%%\$n,'-n)'56784547***+#,,\$n,'1-9:\$ne
./\$0a1\$a "\$23\$456sp1

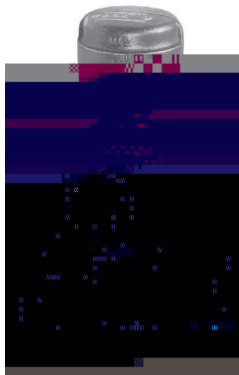

300 D Welding Fitting
See %let in 2100.004



■

Completion

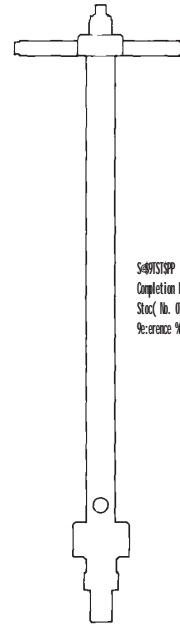

S49Y3TSP E Plugging
Completion Machine
Stock No. 07-1034-0000
Reference %let in 2020.002

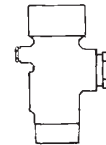

2, casing
08-1742-0000

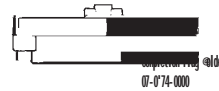

07-074-0000

Tapp "#\$a'd\$\$%&'TST&((
 O)*## "#\$a,- "e\$

® \$

DaB SheetNo. SSS00-3

!"#\$%&ent'(ee)e)'to'+#,'-';/0-s'1-\$n'to'233'%s\$

Tapping

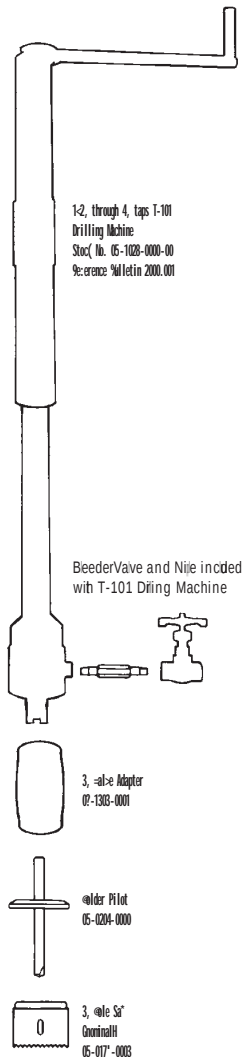

Plugging

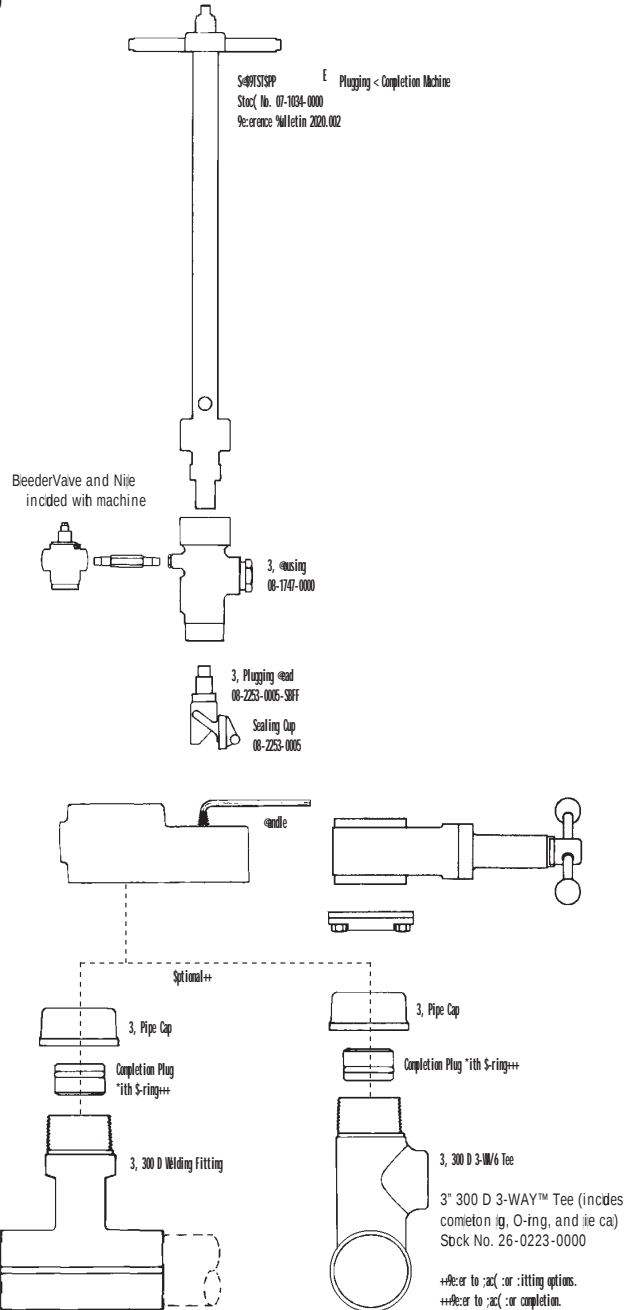

4-%%\$n,'-n)'56784547**

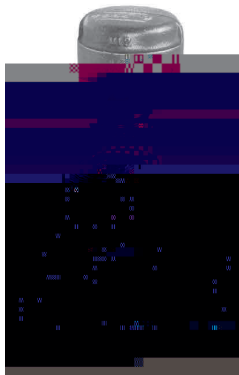

■ 300 D Welding Fitting
See %let in 2100.004

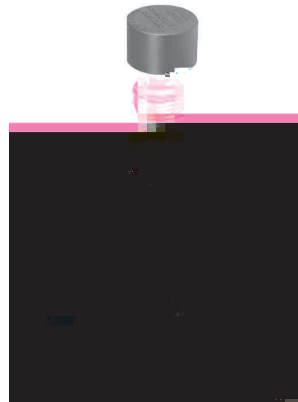

See %let in 2100.008



■ 300 D 3-W/6 Tee
See %let in 2100.002

Tapping

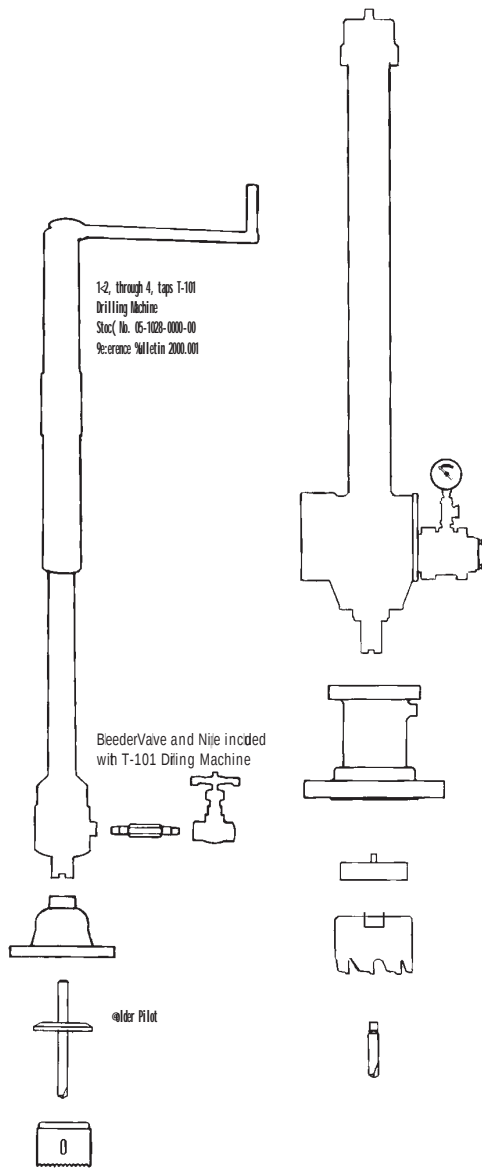

Plugging

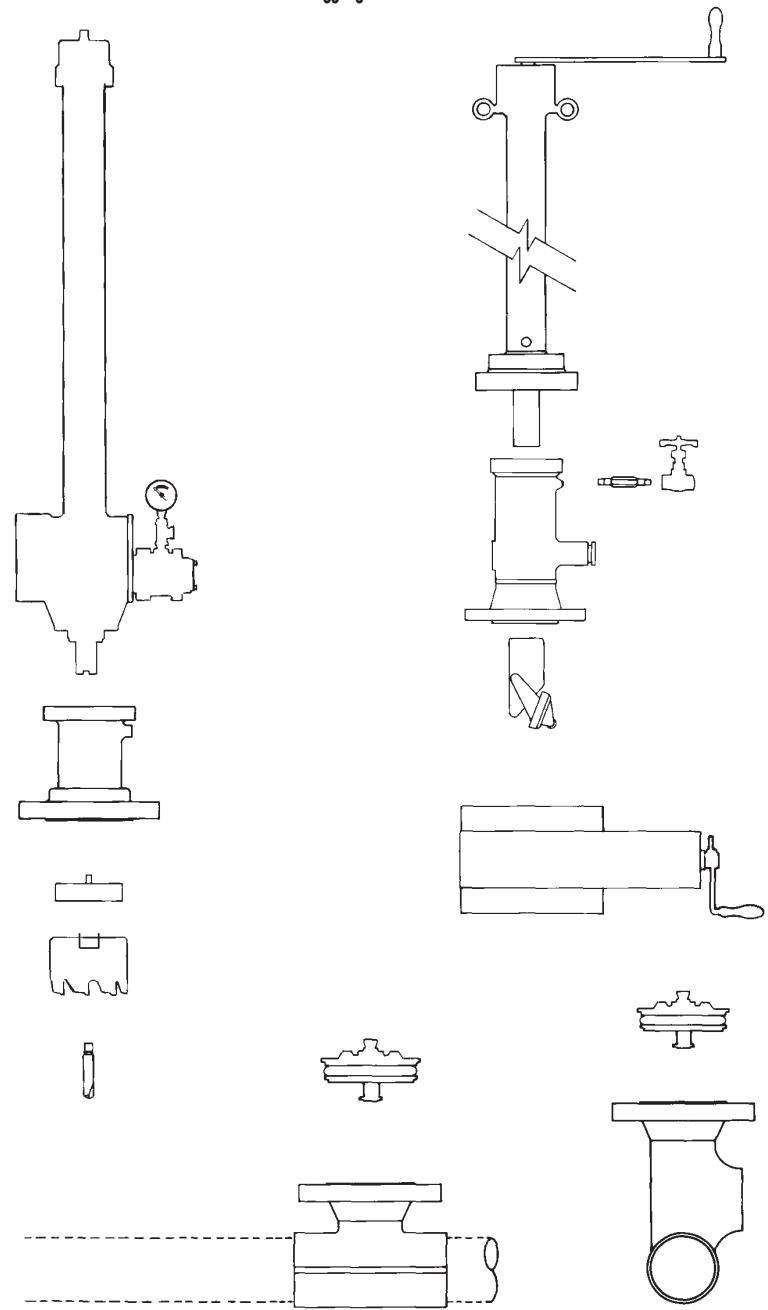

4-%%\$n,'-n)'56784547***+##,\$n,'1-9:\$ne
7/\$0a1\$a "\$23\$4E5\$pl

Completion



Tapping

Plugging

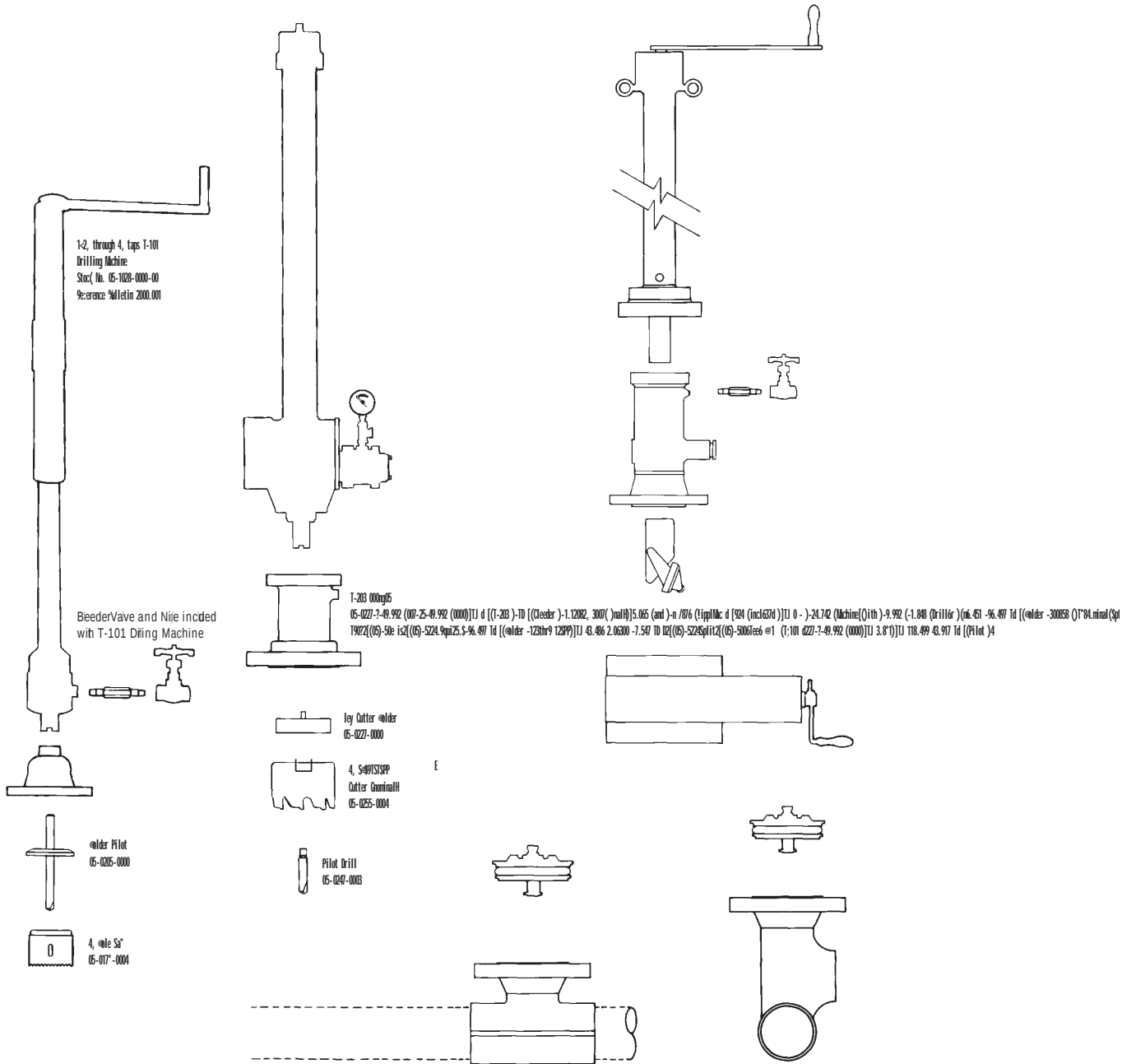



4-%%\$n,'-n)'56784547***+##,\$n,'1-9:\$ne

7/\$0a1\$a "\$23\$456sp1

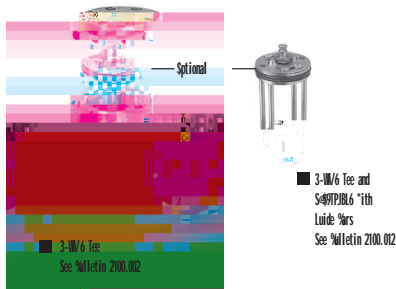
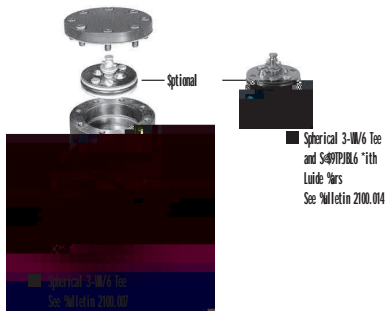
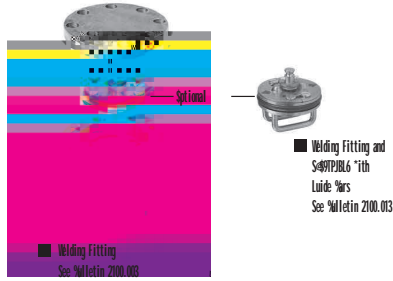

Note: Contact DW representative for additional fitting options

Completion

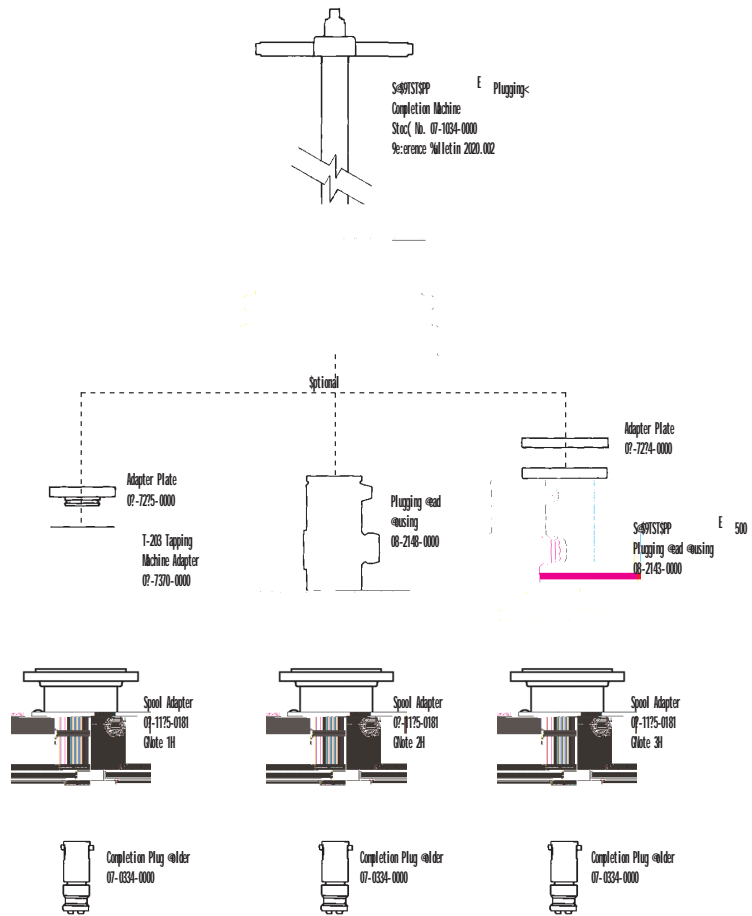

- Note 1: 4-inch Spool Adapter joined to 4-inch SHORTPLUG™ with Guide Basin at SHORTSTOPP 300D Split Tee Fitting using the 06-7370-0000 Housing
- Note 2: 4-inch Spool Adapter joined to 4-inch SHORTPLUG™ with Guide Basin at SHORTSTOPP 300D 3-Way™ Tee Fitting using the 08-2148-0000 Housing
- Note 3: 4-inch Spool Adapter joined to 4-inch SHORTPLUG™ with Guide Basin at SHORTSTOPP 300D 3-Way™ Tee Fitting using the 08-2143-0000 Housing

Plugging

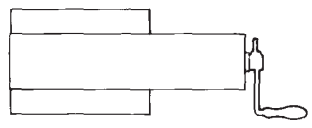
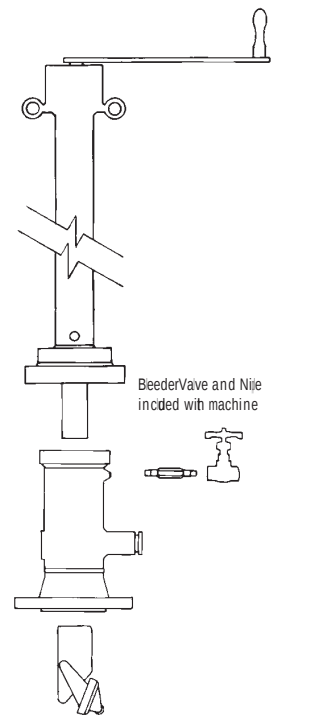

Optional+

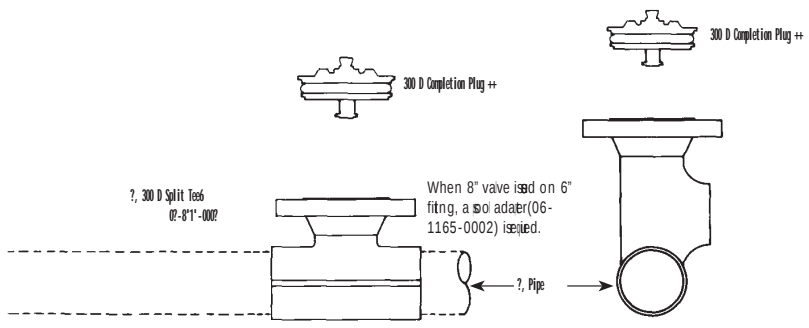

4-%%\$n,'-n)'56784547***+##,\$n,'1-9:\$ne

8/\$0a1\$a "\$23\$456sp1

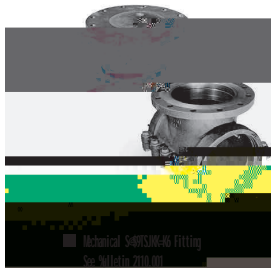
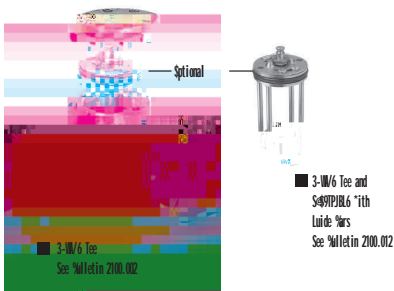
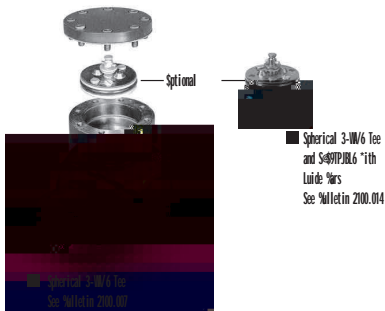
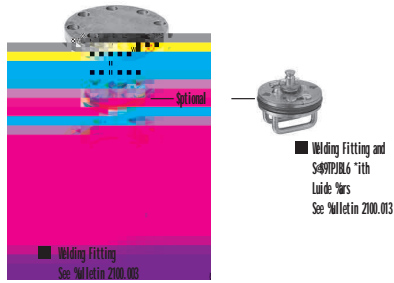

Note: Consult DW representative for additional fitting options

Completion

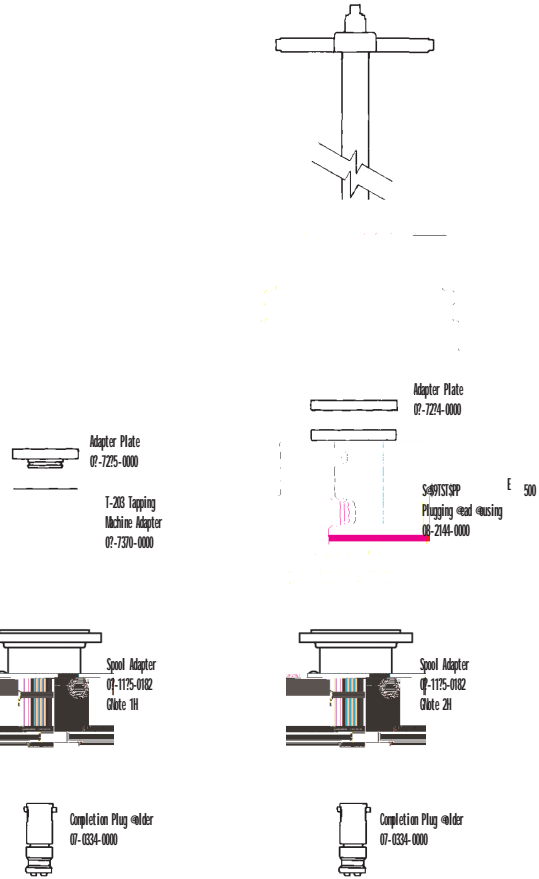

Tapp "#\$a'dSS%&'TST&((
 O)*## "#\$a,- "e\$

® \$



DaB SheetNo. SSS00-8

!"#\$%&ent'(ee)e)'to'+#,'-E/0-s-1-\$n'to'233'%s\$

Tapping

Plugging

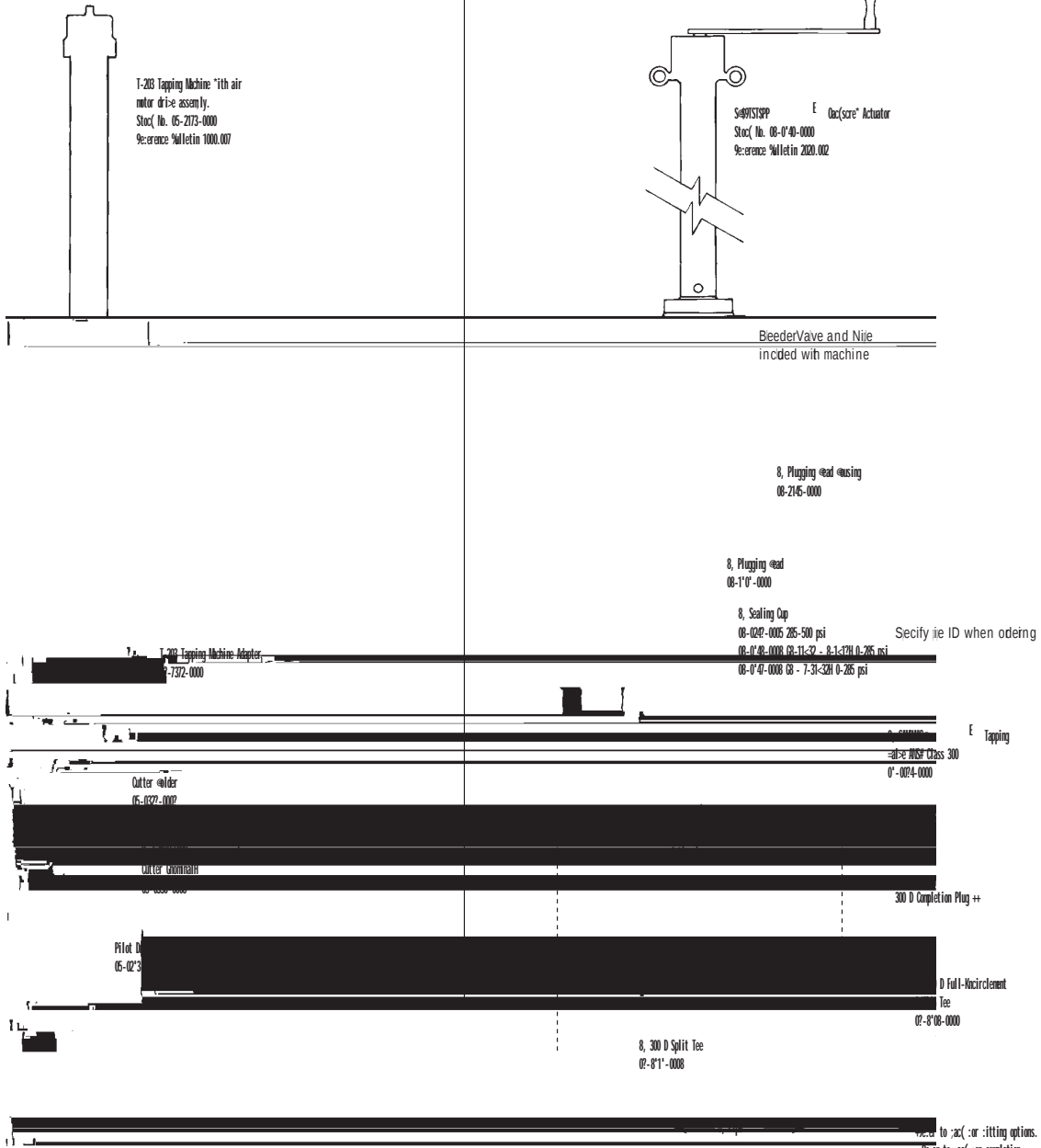

T.D. Williamson® Inc.

■ P.S. 968 340

■ Tulsa® (Alabama 74101-340)

■ 18-447-5000

■ Fax) 18-447-5154

■ ***.tdwilliamson.com

Do not expect change without notice. / Dimensions of for combination specified. / © Registered trademark of T. D. Williamson, Inc. in the United States n'Sa3e n'Sa3e n'Sa3e n'Sa3e n'T.D. Williamson® Inc.

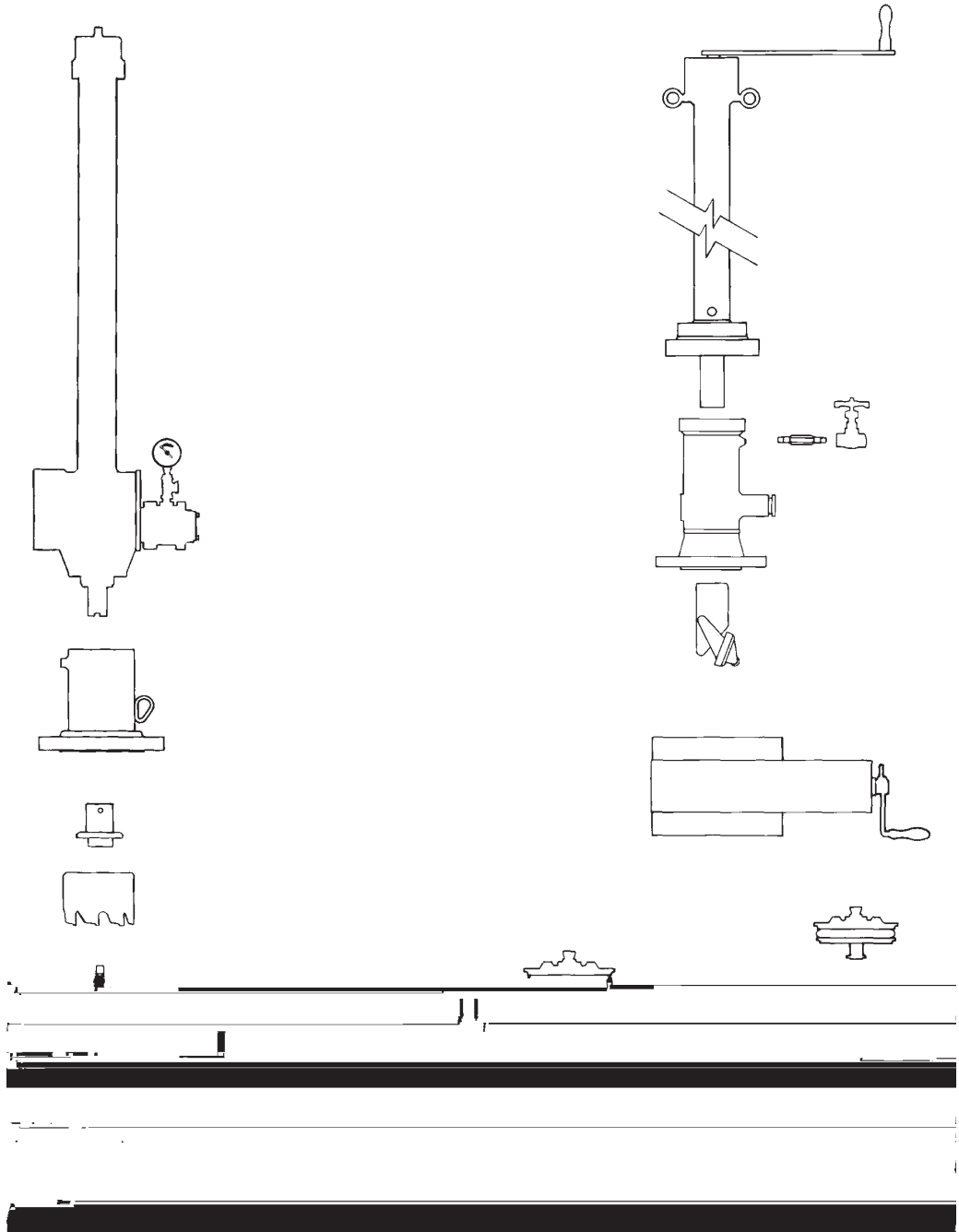

T.D. Williamson" #nc.

■ P.S. %6& 340'

■ Tulsa" \$(ahom 74101-340'

■

Tapping

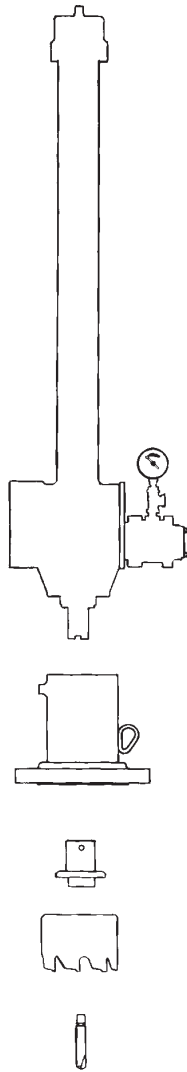

Plugging

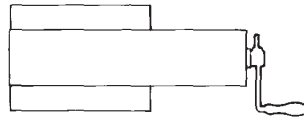
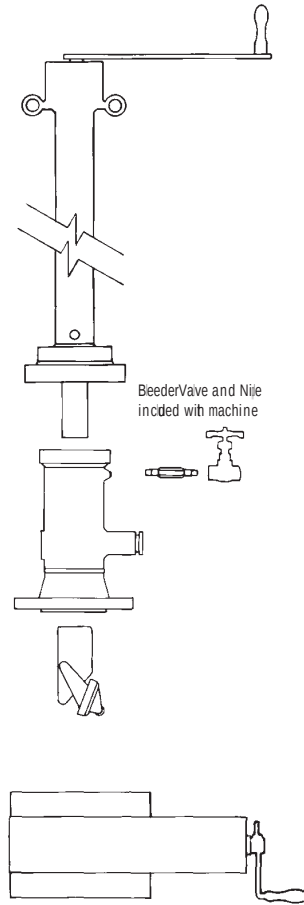

Optional+

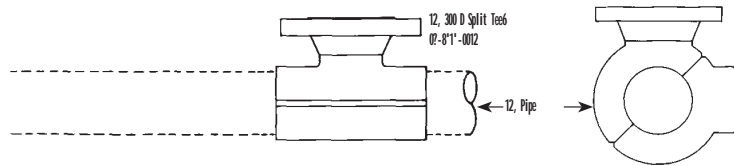
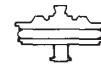
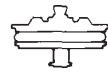



Daß SheetNo. SS500-12

4-%%\$n,'-n)'56784547***+##,\$n,'1-9:\$ne

::,;,\$0a1\$a "\$23\$456\$7 \$2-r3#\$8a:.;,-,\$\$

S% &TST&((\$ (66D&Sp) 25Te&3r&Sp-er,a)\$= 22 "#



300 D Full-encirclement Split Tee
See Bulletin 2100.004



300 Spherical 3-Way Tee and S-491STSP
"ith Luide Hars
See Bulletin 2100.017



300 Spherical 3-Way Tee
See Bulletin 2100.008

Completion

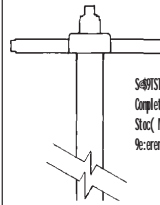

S-491STSP
Completion Machine
Stock No. 07-1034-000
Reference Bulletin 2020.002

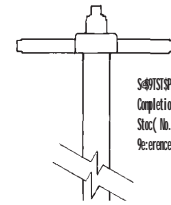

S-491STSP
Completion Machine
Stock No. 07-1034-000
Reference Bulletin 2020.002

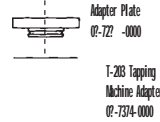

Adapter Plate
07-727-000
T-203 Tapping
Machine Adapter
07-7314-000



Adapter Plate
07-7274-000
S-491STSP
Plugging head casing
08-2147-000



Completion Plug holder
07-0335-000



Completion Plug holder
07-0335-000

■ Note 1: For Tapping and Plugging through a SHORTSTOPP
see SS500-12A Daß Sheet

© 300D 3-Way Tee™

■ Note 2: Only by TDW representative for additional fitting options

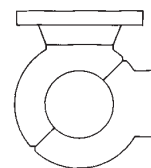
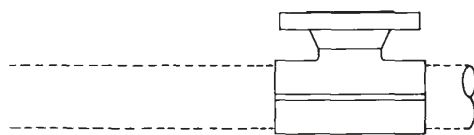
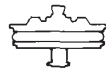
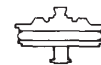
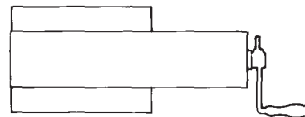
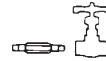
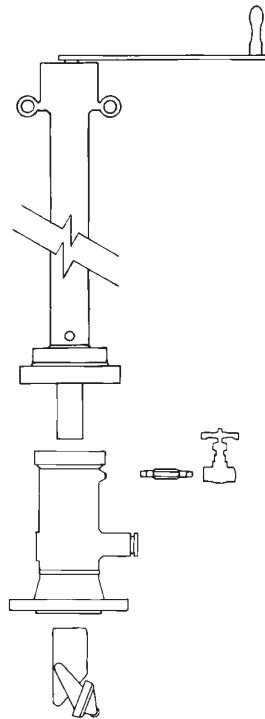
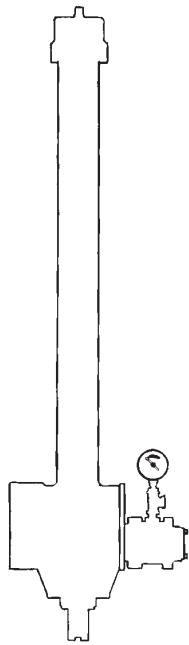

4-%\$n,'-n)'56784547***+##,\$n,'1-9:\$ne

::;,"-\$0a1\$a "\$23\$456\$7\$8-\$r3#\$-a\$::;,"-\$

S% &TST&((\$ (55D\$Sp) 2\$Tee\$3\$Sp-er ,a)\$= 22 "#

Completion

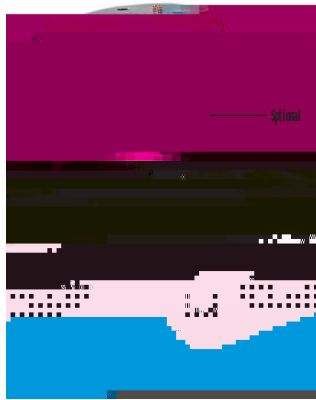

300 D Full-encirclement Split Tee
See Bulletin 2100.004

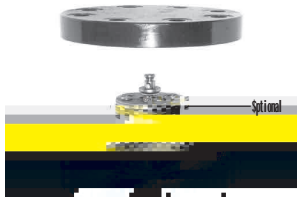

300 Spherical 3-Way Tee and
S-917.8L6 1 1/2 inch Guide Pins
See Bulletin 2100.017

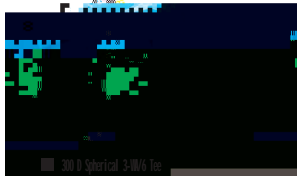

300 Spherical 3-Way Tee
See Bulletin 2100.008

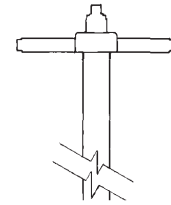

Adapter Plate
07-722-0000
T-203 Tapping

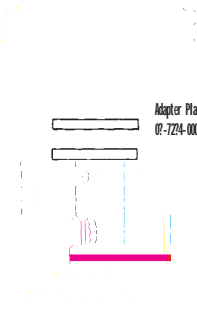

Adapter Plate
07-724-0000

Completion Plug
07-0335-0000



■ Note 1: For Tapping and Pigging through a SHORTSTOPP
see SS500-12A Daß Sheet

© 300D 3-Way Tee™

■ Note 2: Consult DW representative for additional fitting options